

# Mariposa

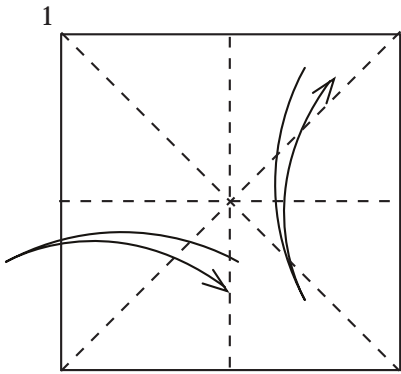

Doblar y desdoblar

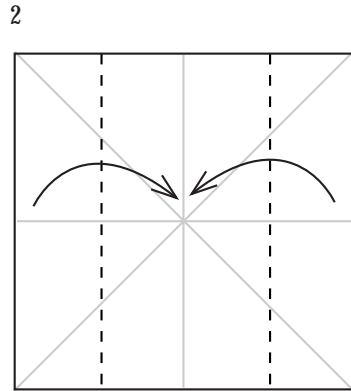

Doblar hacia el centro

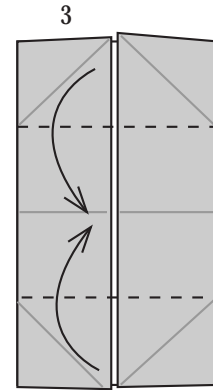

Doblar hacia el centro

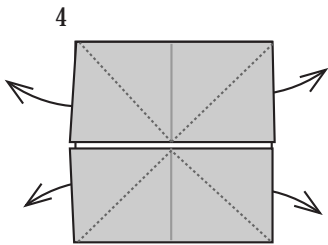

Tirar hacia afuera las cuatro puntas interiores del papel.

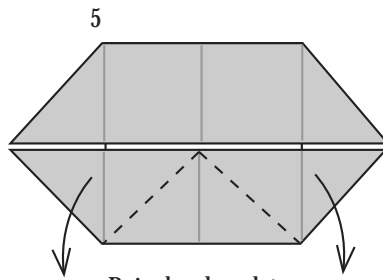

Bajar las dos aletas

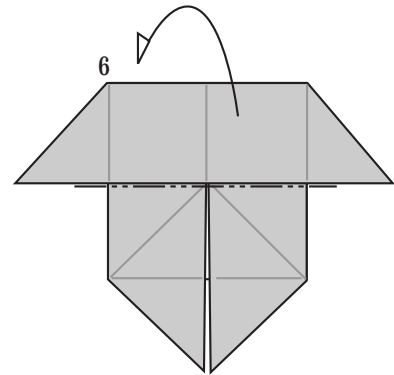

Doblar hacia atrás

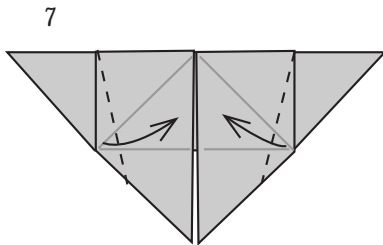

Doblar

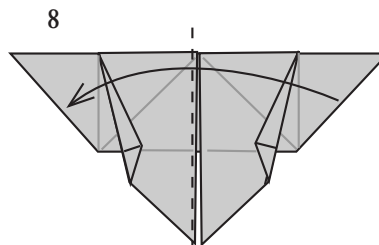

Doblar por la mitad

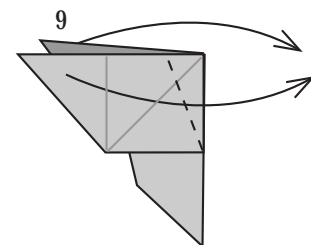

Doblar hacia adelante para marcar las alas

