

Oso Polar

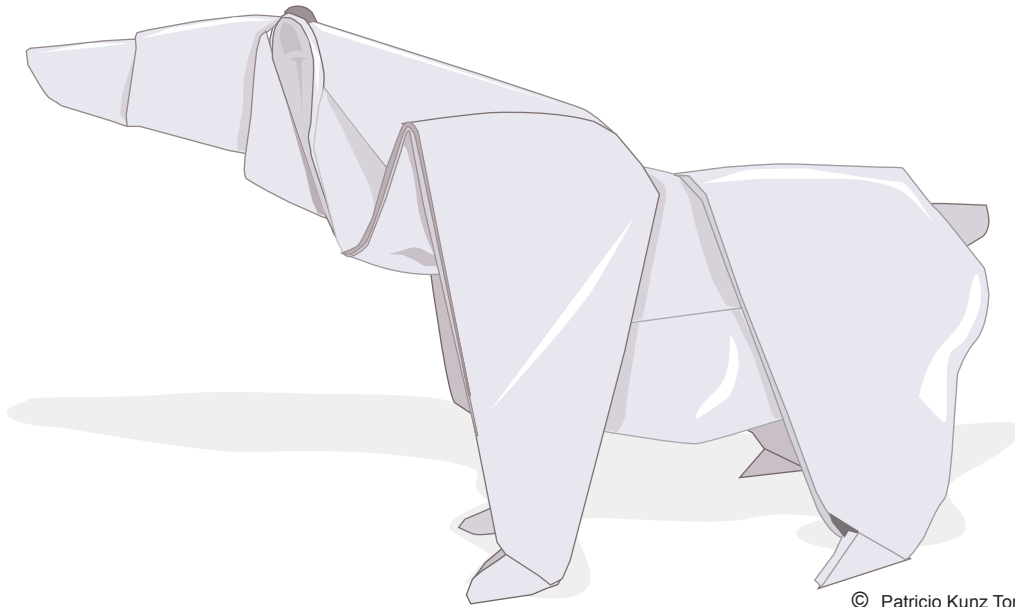

© Patricio Kunz Tomic 2012

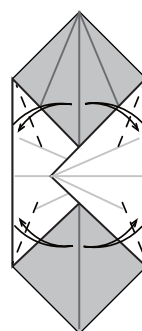
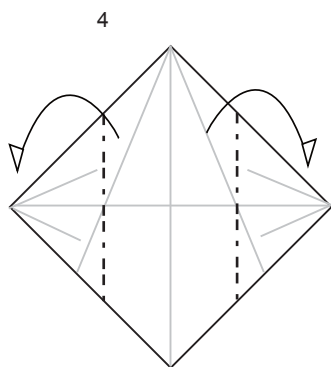
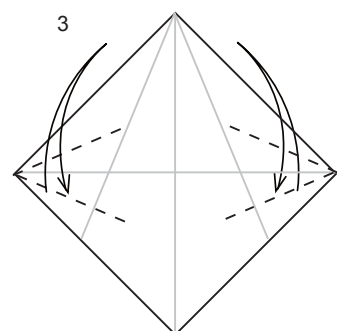
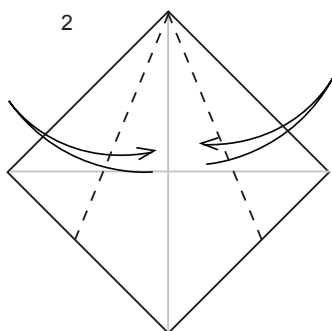
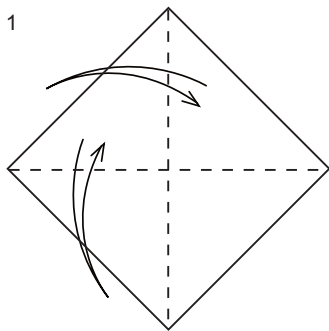

Marcar

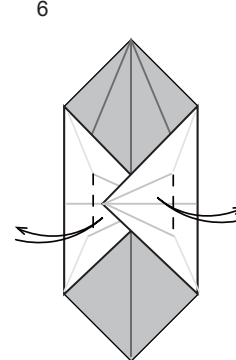

Marcar

7

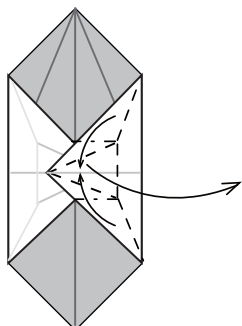

8

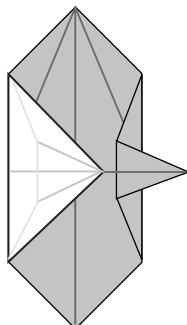

Repetir al otro lado

9

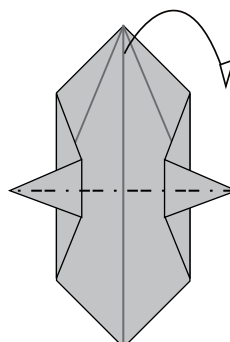

Repetir pasos 5 al 8

10

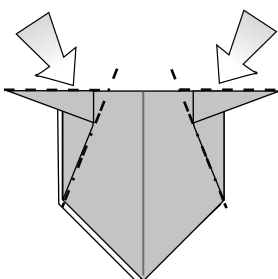

11

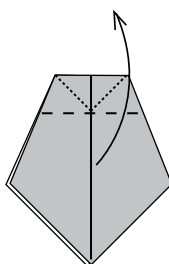

12

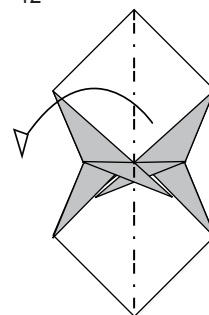

13

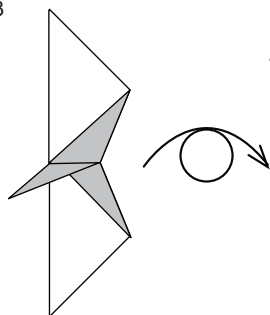

Girar

14

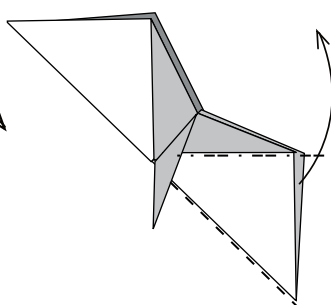

15

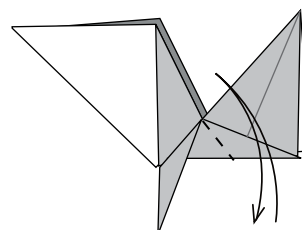

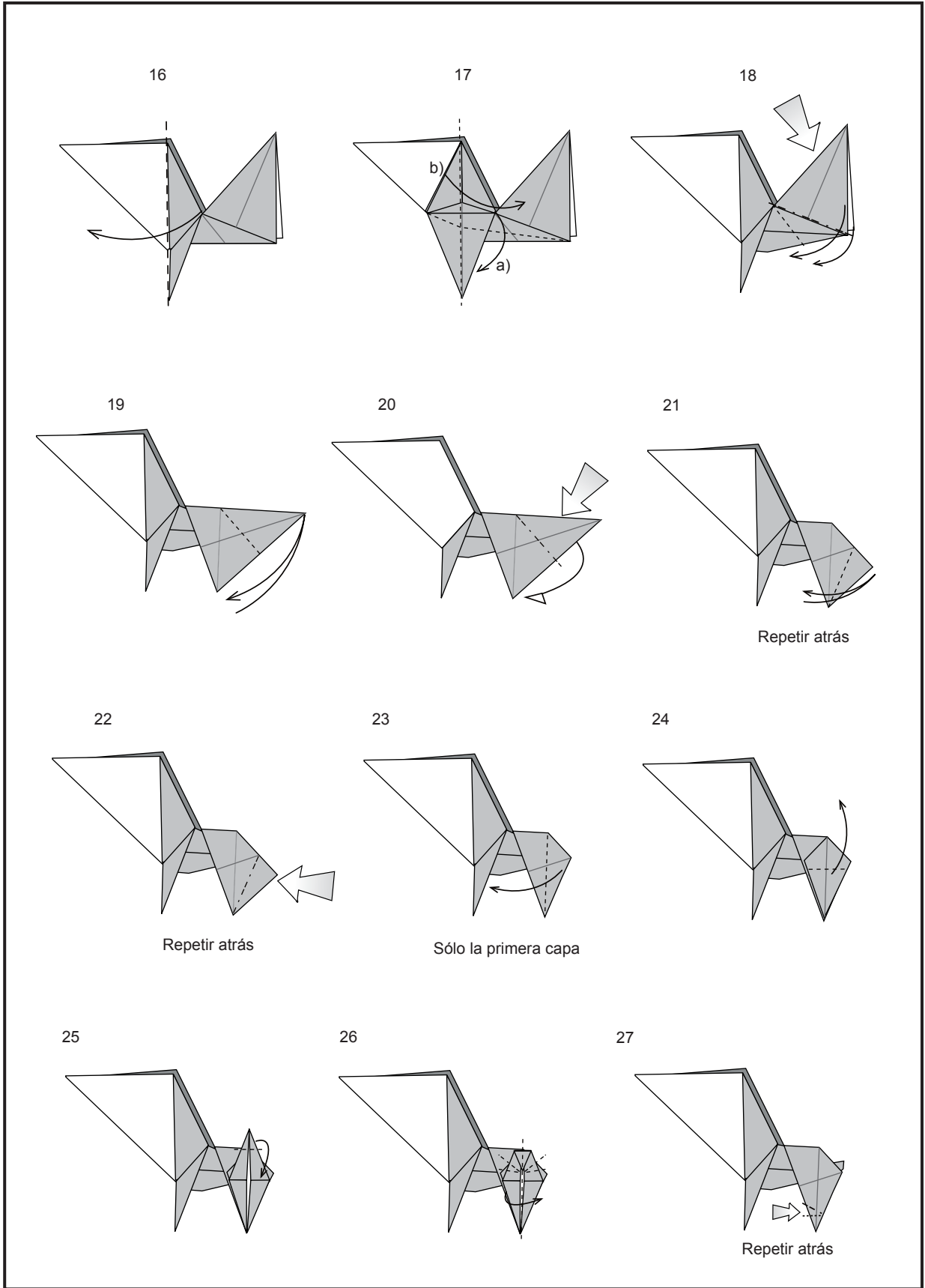

28

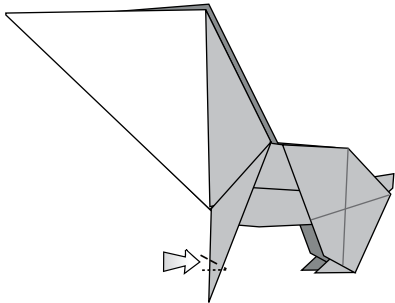

Repetir atrás

29

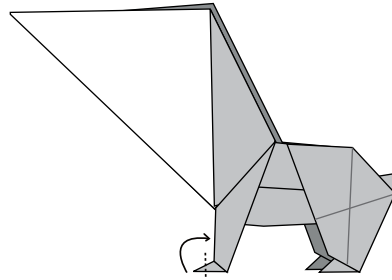

Repetir atrás

30

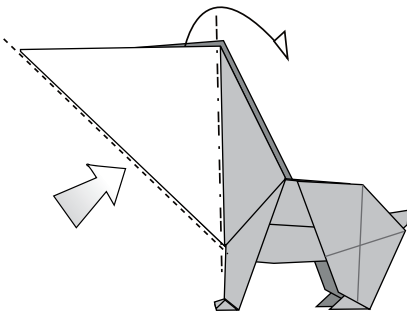

31

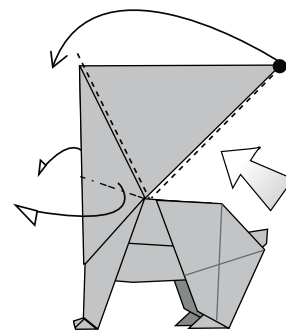

Bajar ambos lados al mismo tiempo

32

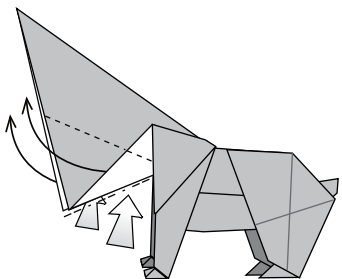

Subir ambos lados al mismo tiempo

33

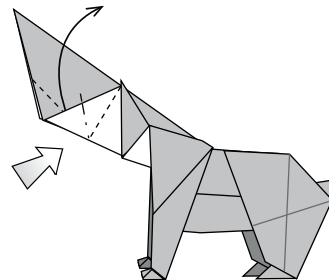

Repetir atrás

34

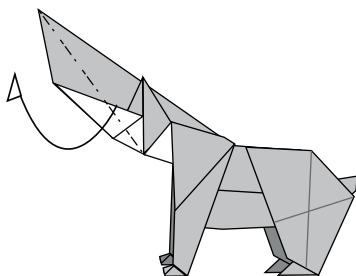

Repetir atrás

35

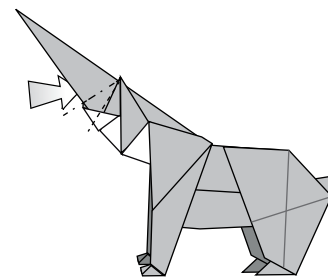

Plegar la cabeza

36

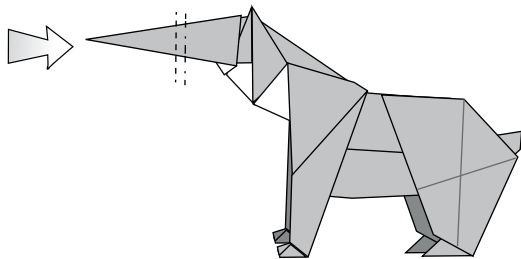

37

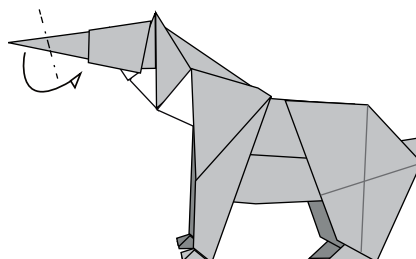

38

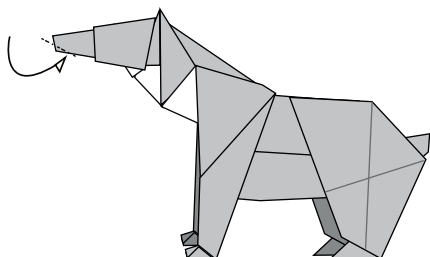

Afinar la nariz

39

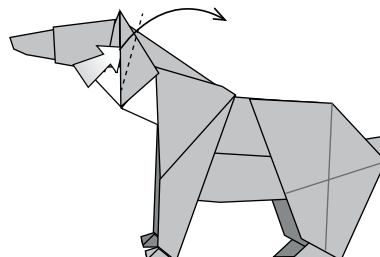

Repetir atrás

40

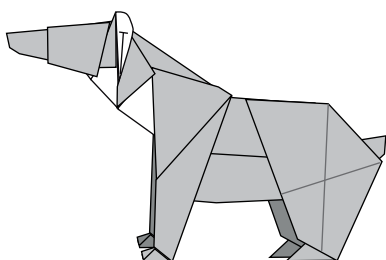

Dar volumen a la figura

41

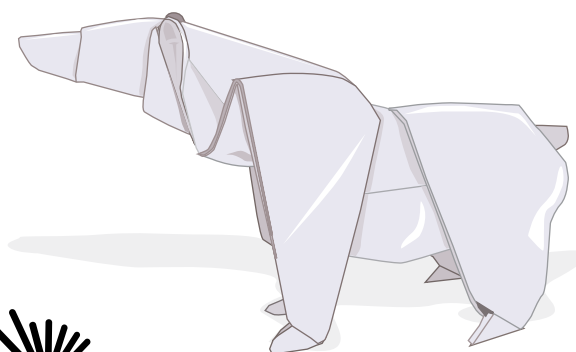

Modelo terminado



ORIGAMI
chile

www.origamichile.cl